

Compact medium speed thick film thermal printhead(8dots / mm)

KD2008-CG50A

KD2008-CG50A is suitable for devices, such as high-speed POS and label printer applications, that require thermal printheads capable of higher printing rates. Improved power circuit design means that with heavier current it is possible to print at speeds as high as 125 mm/s. The GK Series is the thus ideal for label printers that need high printing rates.

●Applications

POS terminal printers
Label printers
CAT printers
General purpose compact printers

●Features

- 1) Using a special compact partial glaze and new heating element structure, achieves high-speed printing at 125 mm/s.
- 2) The use of the newly developed highly-durable conductive protective film has improved countermeasures against static electricity.
- 3) The VH and GND sections of the power circuitry have been strengthened so that heavier current can be applied.
- 4) Ultra small connectors, designed to conform with FFCs, and miniature driver chips have been used.
Although the resulting printheads are surprisingly compact and lightweight, they can be used with large platens of up to 20 mm in diameter.
- 5) One rank resistance value of $800\Omega\pm 3\%$ eliminates the inconvenience of rank selection.

●Dimensions (Units : mm)

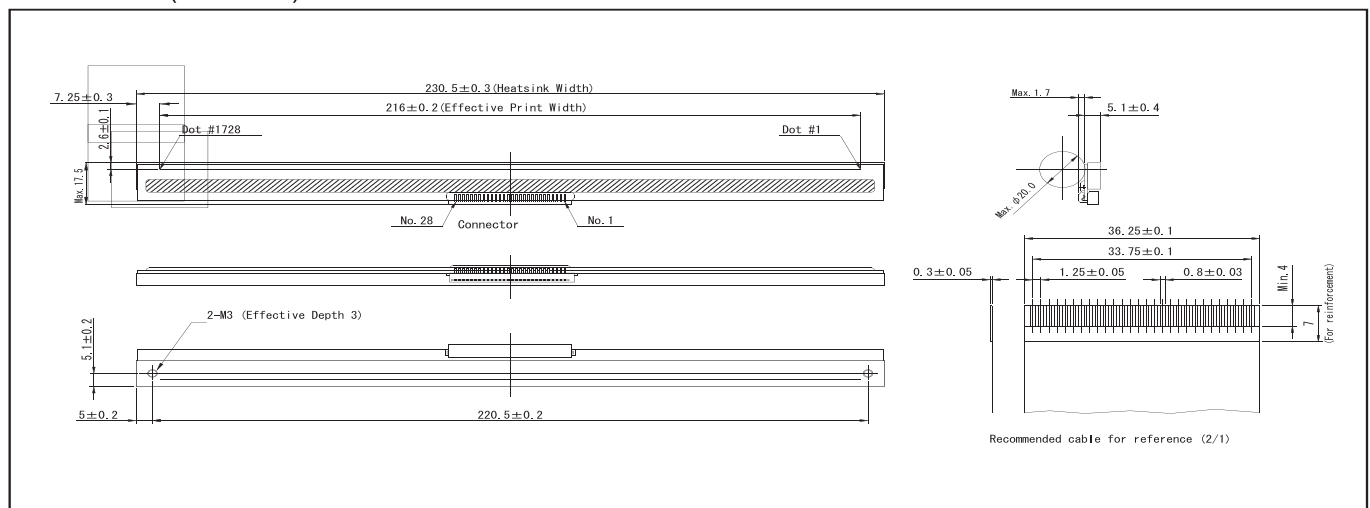

●Inner circuit

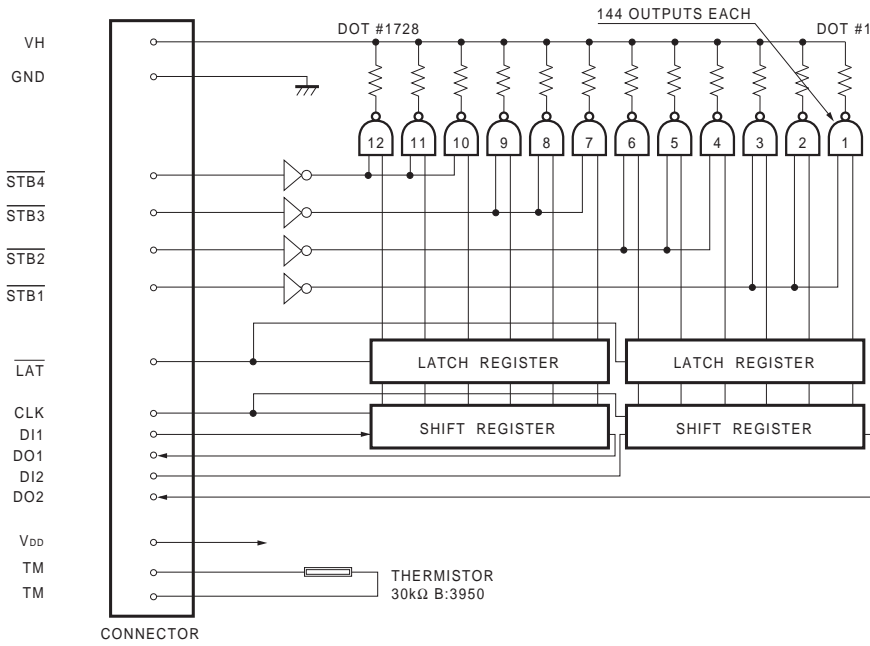

Fig. 1

●Pin configuration

No.	Circuit	No.	Circuit
1	VH	15	GND
2	VH	16	GND
3	VH	17	GND
4	DO2	18	GND
5	DI2	19	TM
6	CLK	20	V _{DD}
7	LAT	21	STB3
8	STB1	22	STB4
9	STB2	23	DO1
10	TM	24	DI1
11	GND	25	VH
12	GND	26	VH
13	GND	27	VH
14	GND	28	VH

●Timing chart

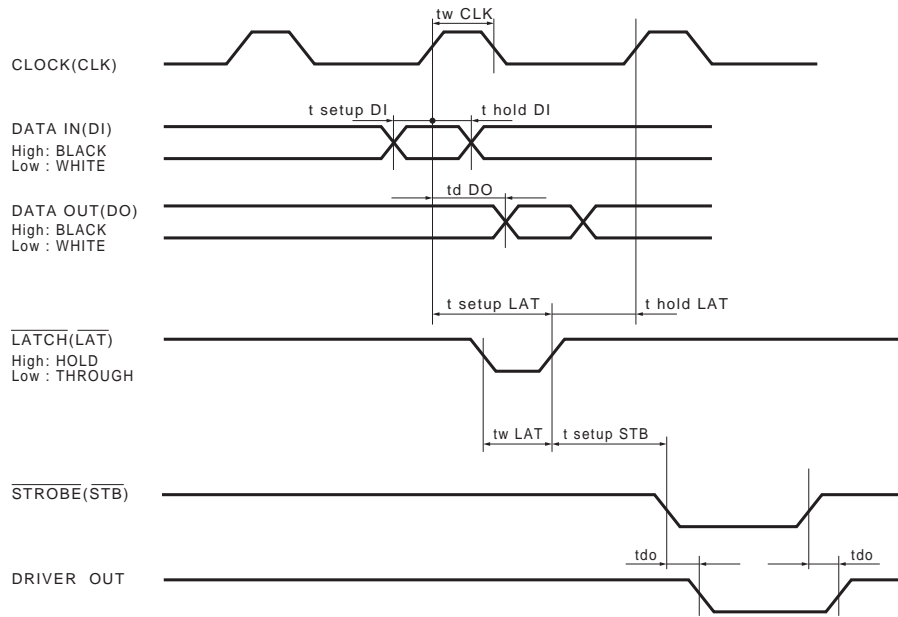

Fig. 2

●Characteristics

Parameter	Symbol	Typ.	Unit
Effective printing width	—	216	mm
Dot pitch	—	0.125	mm
Total dot number	—	1728	dots
Average resistance value	R _{ave}	800	Ω
Applied voltage	V _H	24	V
Applied power	P _o	0.5	W / dot
Print cycle	SLT	1	ms
Pulse width	T _{ON}	0.4	ms
Maximum number of dots energized simultaneously	—	432	dots
Maximum clock frequency	—	5	MHz
Maximum roller diameter	—	20	mm
Running life / pulse life	—	50 / 5×10 ⁷	km / pulses
Operating temperature	—	5~45	°C

●Electrical characteristic curves

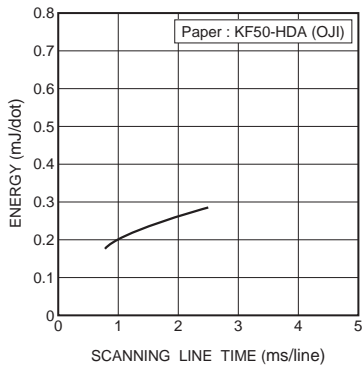

Fig.3 Adaptive speed chart

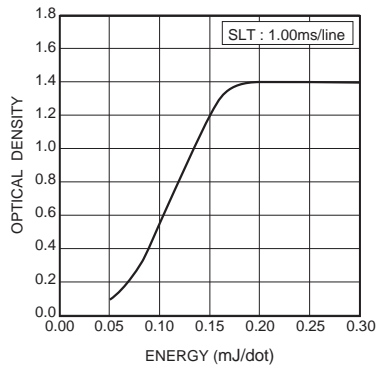

Fig.4 Representative density curve

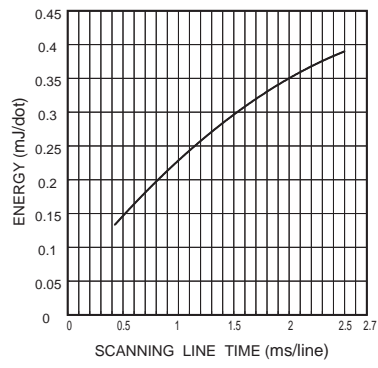

Fig.5 Maximum energy curve

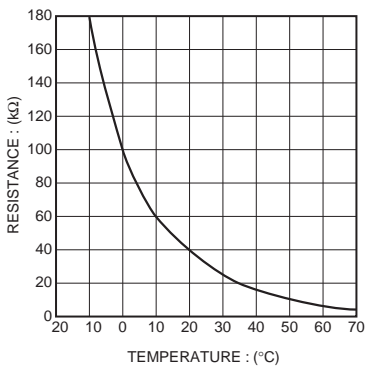

Fig.6 Thermistor curve

Notes

No copying or reproduction of this document, in part or in whole, is permitted without the consent of ROHM Co.,Ltd.

The content specified herein is subject to change for improvement without notice.

The content specified herein is for the purpose of introducing ROHM's products (hereinafter "Products"). If you wish to use any such Product, please be sure to refer to the specifications, which can be obtained from ROHM upon request.

Examples of application circuits, circuit constants and any other information contained herein illustrate the standard usage and operations of the Products. The peripheral conditions must be taken into account when designing circuits for mass production.

Great care was taken in ensuring the accuracy of the information specified in this document. However, should you incur any damage arising from any inaccuracy or misprint of such information, ROHM shall bear no responsibility for such damage.

The technical information specified herein is intended only to show the typical functions of and examples of application circuits for the Products. ROHM does not grant you, explicitly or implicitly, any license to use or exercise intellectual property or other rights held by ROHM and other parties. ROHM shall bear no responsibility whatsoever for any dispute arising from the use of such technical information.

The Products specified in this document are intended to be used with general-use electronic equipment or devices (such as audio visual equipment, office-automation equipment, communication devices, electronic appliances and amusement devices).

The Products specified in this document are not designed to be radiation tolerant.

While ROHM always makes efforts to enhance the quality and reliability of its Products, a Product may fail or malfunction for a variety of reasons.

Please be sure to implement in your equipment using the Products safety measures to guard against the possibility of physical injury, fire or any other damage caused in the event of the failure of any Product, such as derating, redundancy, fire control and fail-safe designs. ROHM shall bear no responsibility whatsoever for your use of any Product outside of the prescribed scope or not in accordance with the instruction manual.

The Products are not designed or manufactured to be used with any equipment, device or system which requires an extremely high level of reliability the failure or malfunction of which may result in a direct threat to human life or create a risk of human injury (such as a medical instrument, transportation equipment, aerospace machinery, nuclear-reactor controller, fuel-controller or other safety device). ROHM shall bear no responsibility in any way for use of any of the Products for the above special purposes. If a Product is intended to be used for any such special purpose, please contact a ROHM sales representative before purchasing.

If you intend to export or ship overseas any Product or technology specified herein that may be controlled under the Foreign Exchange and the Foreign Trade Law, you will be required to obtain a license or permit under the Law.



Thank you for your accessing to ROHM product informations.
More detail product informations and catalogs are available, please contact us.

ROHM Customer Support System

<http://www.rohm.com/contact/>